



**FULL DC INVERTER SYSTEMS  
USER & INSTALLATION MANUAL**

SWC-63

COMMERCIAL AIR CONDITIONERS SDV6



- This manual gives detailed description of the precautions that should be brought to your attention during operation.
- In order to ensure correct service of the wired controller please read this manual carefully before using the unit.
- For convenience of future reference, keep this manual after reading it.

# CONTENTS

## 1 GENERAL SAFETY PRECAUTIONS

- 1.1 About the documentation ..... 01
- 1.2 For the user ..... 02

## 2 BASIC PARAMETERS ..... 04

## 3 ACCESSORIES LIST ..... 04

## 4 OPERATION INSTRUCTIONS

- 4.1 Control Panel Explanation ..... 5
- 4.2 Basic Operation ..... 6
- 4.3 Mode ..... 8
- 4.4 Fan speed ..... 9
- 4.5 Swing ..... 10
- 4.6 Timer ..... 12
- 4.7 Self-cleaning ..... 16
- 4.8 ETA function ..... 17
- 4.9 Air quality monitoring ..... 18
- 4.10 Function settings ..... 19

<b>5 OTHER FUNCTIONS AND SETTINGS</b> .....	23
<b>6 FAQ</b> .....	44
<b>7 INSTALLATION</b>	
• 7.1 Installation Precautions .....	47
• 7.2 Installation Method .....	48
<b>8 ENGINEERING SETTINGS</b> .....	56
• 8.1 Parameter settings of the wired controller .....	56
• 8.2 Engineering Menu .....	57
• 8.3 Wired controller Configuration .....	58
• 8.4 IDU settings.....	59
• 8.5 ODU settings.....	70

---

# 1 GENERAL SAFETY PRECAUTIONS

## 1.1 About the documentation

- The original documentation is written in English. All other languages are translations.
- The precautions described in this document cover very important topics, follow them carefully.
- All activities described in the installation manual must be performed by an authorized installer.

### 1.1.1 Meaning of warnings and symbols

#### **DANGER**

Indicates a situation that results in death or serious injury.

---

#### **DANGER: RISK OF ELECTROCUTION**

Indicates a situation that could result in electrocution.

---

#### **DANGER: RISK OF BURNING**

Indicates a situation that could result in burning because of extreme hot or cold temperatures.

---

#### **WARNING**

Indicates a situation that could result in death or serious injury.

### CAUTION

Indicates a situation that could result in minor or moderate injury.

---

### NOTE

Indicates a situation that could result in equipment or property damage.

---

### INFORMATION

Indicates useful tips or additional information.

## 1.2 For the user

- If you are not sure how to operate the unit, contact your installer.
- The appliance is not intended for use by persons, including children, with reduced physical, sensory or mental capabilities, or lack of experience and knowledge, unless they have been given supervision or instruction concerning use of the appliance by a person responsible for their safety. Children must be supervised to ensure that they do not play with the product.

### CAUTION

Do NOT rinse the unit. This may cause electric shocks or fire.

## NOTE

- Do NOT place any objects or equipment on top of the unit.
- Do NOT sit, climb or stand on the unit.

- Units are marked with the following symbol:



This means that electrical and electronic products may not be mixed with unsorted household waste. Do not try to dismantle the system yourself: the dismantling of the system, treatment of the refrigerant, of oil and of other parts must be done by an authorized installer and must comply with applicable legislation. Units must be treated at a specialized treatment facility for reuse, recycling and recovery. By ensuring this product is disposed of correctly, you will help to prevent potential negative consequences for the environment and human health. For more information, contact your installer or local authority.

## 2 BASIC PARAMETERS

<b>Items</b>	<b>Description</b>
Rated voltage	DC18V
Wiring size	RVVP-0.5mm <sup>2</sup> × 2
Operating environment	-5°C ~ 43°C
Humidity	≤ RH90%

## 3 ACCESSORIES LIST

<b>No.</b>	<b>Name</b>	<b>Quantity</b>
1	Wired controller	1
2	Philips head screw, M4×25	2
3	Installation and Operation Manual	1
4	Plastic support bar	2
5	Bottom cap of the wired controller	1
6	Round head screw ST4X20	4
7	Plastic expansion pipe	4

## 4 OPERATION INSTRUCTIONS



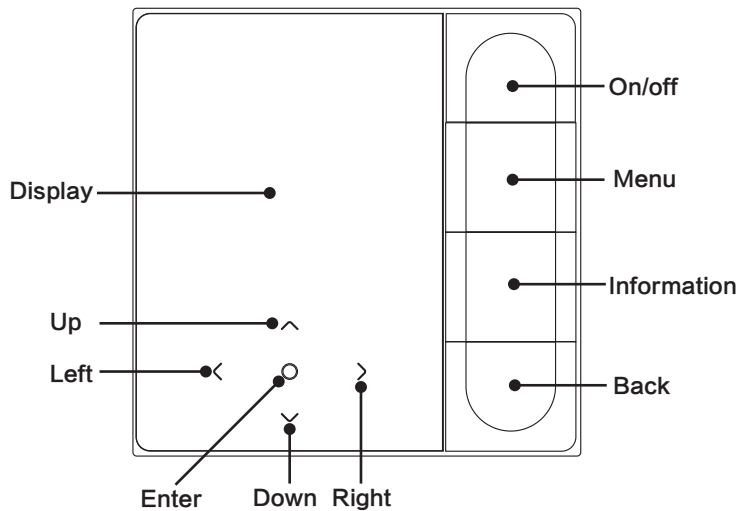













### 4.1 Control Panel Explanation





















## 4.2 Basic Operation

1. **On/Off** Press " On/Off ". The interface/operation button will light up and the device will start. Under one-to-many individual control, the screen will not die when the power-off button is pressed. Press " On/Off " again. The screen/operation button will be off, and the device will shut down.
2. **Menu** Press " Menu " to enter the menu selection screen.
3. **back** Press " Back " to return to the previous menu
4. **Left/Right key** Press " < " " > " to adjust the fan speed.
5. **up/down** Press " ∨ " " ^ " to adjust the temperature and humidity.
6. **Confirmation** Press " ○ " to wake up the screen.
7. **Information** Press " Information " to view error codes.

 26.5 <sup>°C</sup> Set temperature display	 Indoor temp.
 Timer OFF	 Timer ON
 Cool	 Heat
 Auto	 Dry
 Main/secondary	 Filter Blockage
 Fan	 ETA function
 WiFi	 Home leaving mode
 Vertical swing	 Horizontal swing

 Sterilization	 Sleep
 Aux heater	 ECO
 3D circulating air	 Comfort
 Blow on people	 Avoid people
 Silent IDU	 Backup running
 Fault prompt	 Key lock
 Schedule	 Lock mode
 Rapid cooling	 Rapid heating
	
Air quality monitoring:good,middle,poor	

## 4.3 Mode

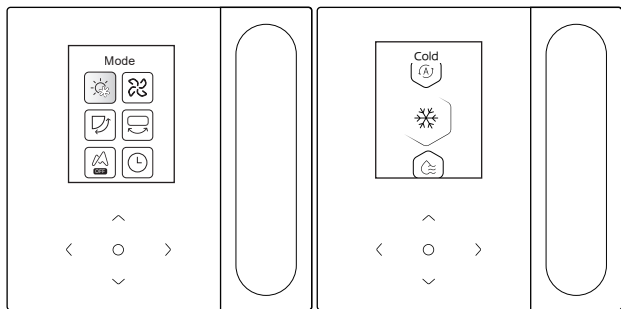

Select the mode on the menu and press "○" for confirmation. After entering the mode, press "▽" or "△" to select the operating mode, and press "○" for confirmation. Or press "Back" to exit.

Mode conflict:

1. When the system detects any mode conflict, the main screen of the wired controller will display a message indicating that no heating or cooling option is available.
2. All IDUs in the same air conditioning system can only operate in the same mode (such as cooling and heating). A conflict will occur if the IDUs operate in different modes. Therefore, make sure that the operating mode of all IDUs is the same.

Auto mode is specific to some IDUs; Dry mode is not supported on FAPUs.

## 4.4 Fan speed

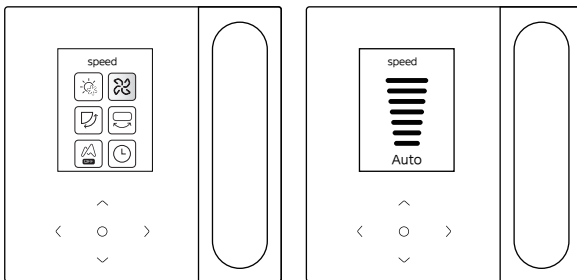

Select the fan speed on the menu, and press "○" for confirmation. After entering the fan speed interface, press "▽" or "△" to select the operating speed, or press "Back" to return to the menu.

### CAUTION

- Depending on IDU models, 3 speeds or 7 speeds are supported.
- With efficiency ensured, the air conditioner may adjust the fan speed depending on the indoor temperature, leading to a difference between the real-time fan speed and the set one or causing the fan to stop. This is normal.
- After the fan speed is set, it takes time for the air conditioner to respond. It is normal if the air conditioner does not respond to the setting immediately.

## 4.5 Swing

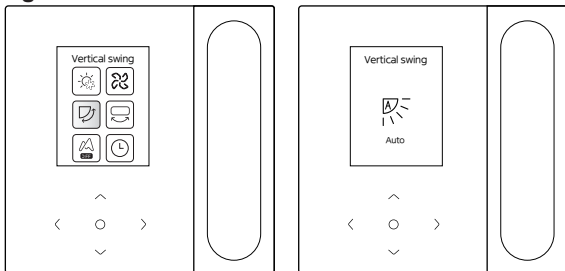

Select the swing (up/down) left/right function on the menu, and press "○" for confirmation. After entering the swing interface, press "▽", "△", "◀" or "▶" to adjust the swing angle, or press "Back" to return to the menu.

### CAUTION

- Some IDUs do not support the swing feature.
- When the unit is off, the wired controller automatically shuts louvers of the air outlet.

## Independent swing

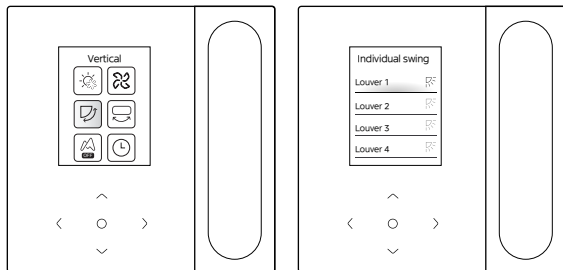

Select the swing up/down function on the menu, and press "○" for confirmation. After entering the swing interface, press "∨" or "∧" to select the air outlet to be controlled, or press "○" to adjust the swing angle.

### CAUTION

- Independent swing only applies to IDUs with an independent swing device.

## 4.6 Timer

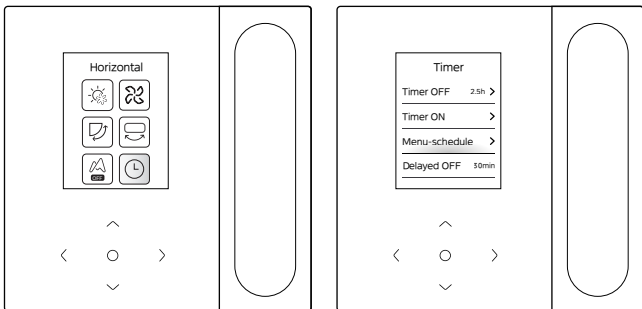

Select the timer function on the menu, and press "○" for confirmation. After entering the timer interface, press "▽" or "△" to select the corresponding timer, and press "○" to start function setting.

- 1. Timer OFF:** Enter the timed off interface, press "▽" or "△" to set the power-off time, press "<" or ">" to switch minutes and hours, and press "○" for confirmation and return to the home page to display the timer period.
- 2. Timer ON:** Enter the timed on interface, press "▽" or "△" to set the power-on time, press "<" or ">" to switch minutes and hours, and press "○" for confirmation and return to the home page to display the timer period.
- 3. Menu-schedule:** Enter the menu-schedule interface. You may turn on more than one schedule. When a schedule is enabled, the air conditioner will go on and off at the specific times. The parameters and operation cycles of all schedules are configurable.

## Menu-schedule

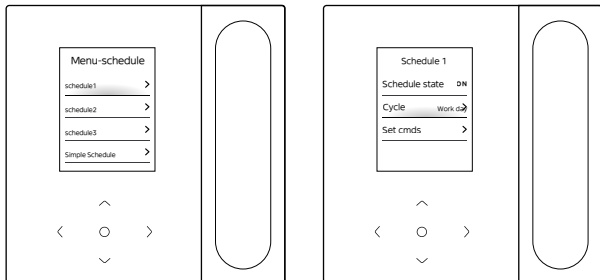

Menu-schedule include three regular schedules(the first,second and third) and simple schedule, you can set the schedule on/off to enable or not, the Repeating date, and the schedule act. Press "∨" or "∧" to switch the set object, and press "○" to switch the settings.

- Holiday setting

You can choose one or more days as a holiday. After a holiday is set, the air conditioner will not execute the Menu-schedule during the holiday.



## Set act

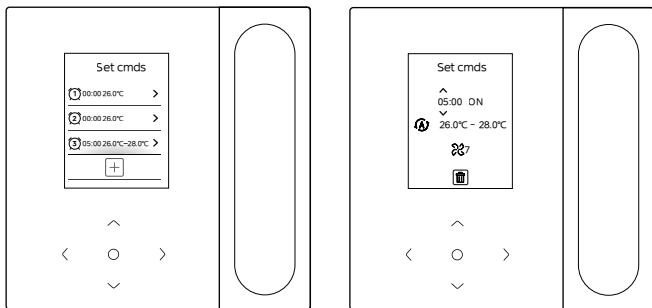

### (1) Simple Schedule

You can set up to five acts, each of which contains the time and power-on/off information. Press "<" or ">" to switch the set object, and press "∨" or "∧" to switch the settings. Upon the setting, press "○" or "back" to save the settings and return.

### (2) Schedule

You can set up to five acts, each of which contains the time, mode, fan speed and set temperature. Press "<" or ">" to switch the set object, and press "∨" or "∧" to switch the settings. Upon the setting, press "○" or "back" to save the settings and return.

 **CAUTION**

- There should not be more than one schedule act at the same time. Otherwise, a conflict may occur.
- Complete the date setting before the first schedule setting.

- **Delayed off**

This function is only effective after the schedule is enabled. After delayed off is set, the air conditioner will delay its shutdown in accordance with the set delay based on the original schedule power-off time.

 **CAUTION**

- Delayed off is one-off. After executing a power-off delay act, you have to set another delayed off act to execute such function again.

## 4.7 Self-cleaning

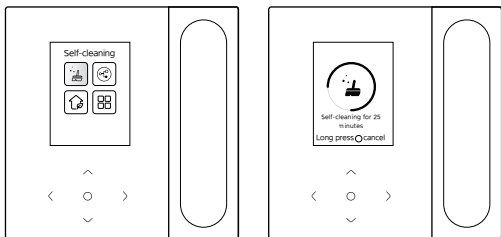

Select the self-cleaning function on the menu.

The self-cleaning process takes approximately 50 minutes and falls into four steps:

Pretreatment ➡ Icing ➡ De-icing and Rinsing ➡ Drying

### CAUTION

- You can quit the timer by long pressing " ○ " to stop self-cleaning or pressing " ⏻ " to stop directly.
- Some models do not have self-cleaning function. For details, please refer to the manual of IDU.
- When self-cleaning is enabled, all IDUs (sharing the same ODU) start the process of self-cleaning.
- During the process of self-cleaning, the IDUs may blow out cold or hot air.

## 4.8 ETA function

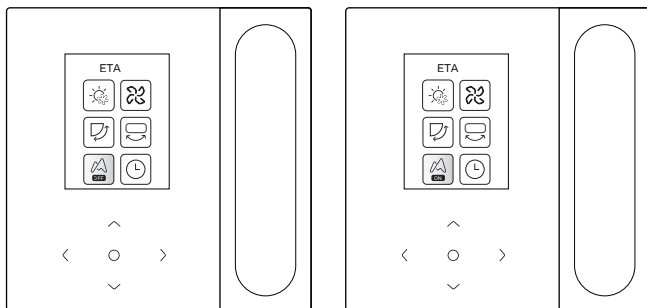

Select the ETA function on the menu, and press "  " to enable or disable the ETA function. The ETA function is real-time energy saving.

## 4.9 Air quality monitoring

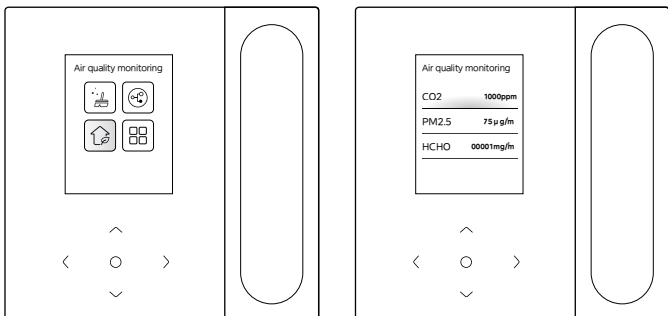

Select the air quality function on the menu, and check the air quality indicators such as AQI, PM2.5 and CO<sub>2</sub> in real time. Indoor air quality monitoring requires adequate configuration of the IDU.

## 4.10 Function settings

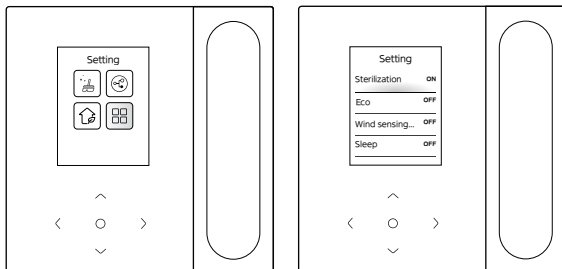

Select the function setting on the menu, and press "○" for confirmation. After entering the function setting interface, press "∨" or "∧" to switch the function, and press "○" to enable the selected function.

**Sterilization:** After sterilization is enabled, the home page will show a



sterilization icon " ".

### CAUTION

- It works only with the IDU with sterilization feature.
- The sterilization module stops when the swing function is enabled, and does not resume operation until the swing function is disabled.

**Sleep:** After sleep is enabled, the home page will show a sleep icon.



The sleep function is only applicable to cooling and heating modes and unavailable for auto, dry and fan modes.

With sleep enabled, it will be cancelled after manual power-off or mode switching. You have to re-enable this function.

Sleep mode is not supported on FAPUs.

**Auxiliary heat source:** The auxiliary heater has four modes:



Auto Operation of Auxiliary Heater, Auxiliary Heater Enabled, Auxiliary Heater Disabled, and Auxiliary Heater Used Separately.

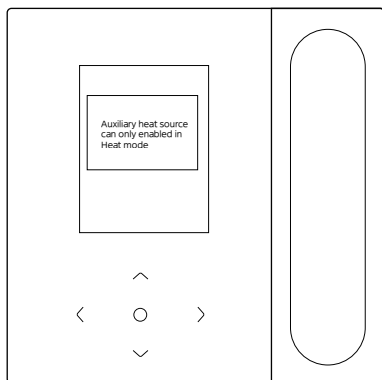

 **CAUTION**

- **Auto Operation of Auxiliary heat source:** Upon power on, the air conditioner will determine whether to start the auxiliary heat source automatically based on the ambient temperature in heating mode. At this moment, the air conditioner operates in "Auto Operation of Auxiliary heat source" mode.
- **Auxiliary heat source Used Independently:** The auxiliary heat source can be used independently without starting the compressor. It only applies to certain customized models.
- **The auxiliary heat source can only be started in heating mode.** The auxiliary heat source is an additional heating component to the air conditioner, but the power consumption will increase after the auxiliary heat source starts working.

**Powerful operation:** After powerful operation is enabled, the IDU will accelerate cooling/heating. Powerful operation is only available for cooling or heating mode.

After powerful operation is enabled, the maximum runtime of the IDU is 30 minutes. After powerful operation is disabled, the IDU will be controlled normally.

Power operation will quit in case the operating mode or fan speed is changed.



**Wind sensing of smart panel :** The wired controller can set the IDU air flow to "Comfortable" or "Off". If the air flow is set to "Comfortable", the fan speed and swing angle of the IDU will automatically adjust to a relatively comfortable level. This function only applies to IDUs with air flow setting feature.

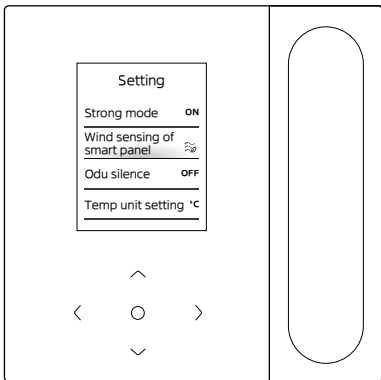

## 5 OTHER FUNCTIONS AND SETTINGS

- 5.1 APP control ..... 24
- 5.2 Home leaving mode ..... 29
- 5.3 ECO setting by human sensor ..... 30
- 5.4 Silent IDU..... 31
- 5.5 Temperature unit setting..... 32
- 5.6 Room temp.display..... 33
- 5.7 IDU lighting..... 34
- 5.8 Backlight time..... 35
- 5.9 Backlight brt..... 35
- 5.10 The temperature setting in auto mode ..... 36
- 5.11 Key lock..... 37
- 5.12 Daylight saving time ..... 38
- 5.13 Date and time setting..... 39
- 5.14 One-to-more..... 41
- 5.15 Fault Prompt..... 43

## 5.1 APP control

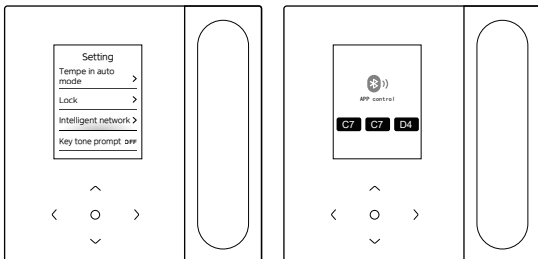

When smart networking is enabled, you can control your smart devices with APP.  
iLetComfort appliances networking guidelines

- 1 Download iLetComfort App  
Scan the QR code below, or search for "iLetComfort" in Google play(Android devices) or App Store (ios devices) to download the app;



**2 Register or Login account**

Open the app and create a user account, if you already have one, just log in.



**3 Add your appliance**

Tap the "+" icon to add home appliance to your iLetComfort account.

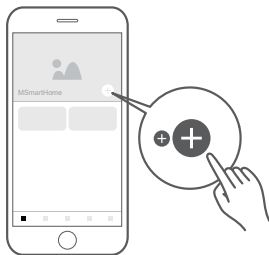

**4 Connected to the network**

Follow the instructions in the app to set up the WiFi connection. If the network connection fails, please refer to the App tips for operation.

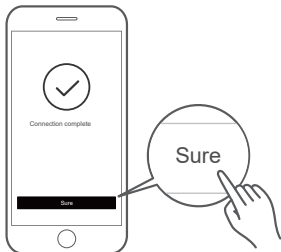



## NOTE

Notes on networking:

- When networking the product, please make sure that the mobile phone is as close as possible to the product.
- According to the App tips, if the product only supports 2.4GHZ WiFi communication, please note that the 2.4GHZ network is selected for connection.
- Sinclair recommends WiFi router SSID names contain only alphanumeric values. If special characters, punctuation marks or spaces are used it might prevent the SSID name from showing up in the available networks to join in the App. Try it and if the SSID shows up then it is ok to use, otherwise log into the router and change the SSID name.
- A large number of devices on the WiFi router can affect network stability, there is no way that Sinclair can advise a specific number limitation as this depends on router quality and many other factors.
- If the router or WiFi name and WiFi password change, please repeat the above process to reconnect to the network.
- As the product technology is updated, the content of SmartHome may change, and the actual display in SmartHome App shall prevail.

## WARNING

Warning and troubleshooting for networking failures:

- When the product is connected to the network, please make sure that the phone is as close as possible to the product.
- We only support 2.4GHz band routers at present.
- Special characters (punctuation, spaces, etc.) are not recommended as part of the WLAN name.
- It is recommended that you connect no more than 10 devices to a single router lest home appliances are affected by weak or unstable network signal.
- If the password of the router or WLAN is changed, clear all settings and reset the appliance.
- The contents of App might change in version updates and actual operation shall prevail.

WiFi information

WiFi transmit frequency range:2.400~2.4835 GHz  
EIRP not more than 20dbm

## 5.2 Home leaving mode

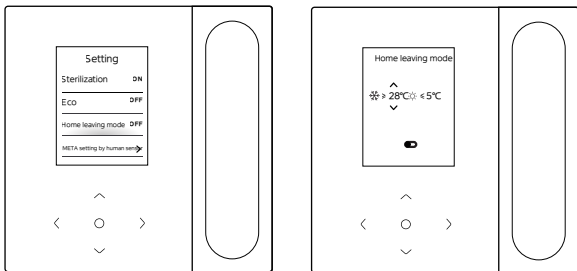

When the Home leaving mode is enabled and Indoor temperature reaches the set value, the air conditioner will activate cooling or heating mode. You can press "<" or ">" to select an item, and press "∨" and "∧" to adjust the temperature, or press "○" to adjust on/off.



## 5.3 ECO setting by human sensor

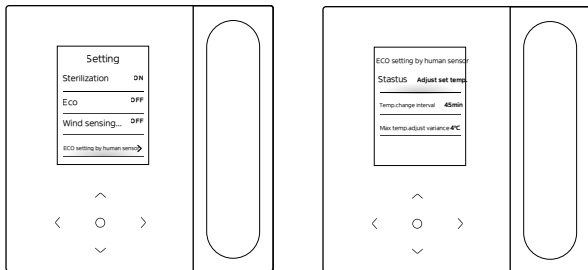

The ECO setting by human sensor is enabled when no one is detected, You can select the "Staus" and press "○" to choose between automatic temperature adjustment and automatic power off modes.

1. Adjust set temp.: Press "∨" or "∧" to select the Temp.change interval or Max temp.adjust variance,and press"○" to adjust the time or temperature.
- 2.Power OFF: Press "∨" or "∧" to select the Power-off delay time,and press"○" to adjust the time.

## 5.4 Silent IDU

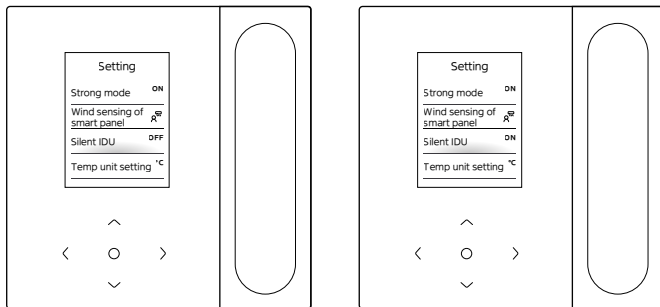

After "Quiet IDU" is enabled, the IDU will operate in silence.

You can press "  " to enable or disable the function.

### NOTE

- Silent mode is not supported on FAPUs

## 5.5 Temperature unit setting

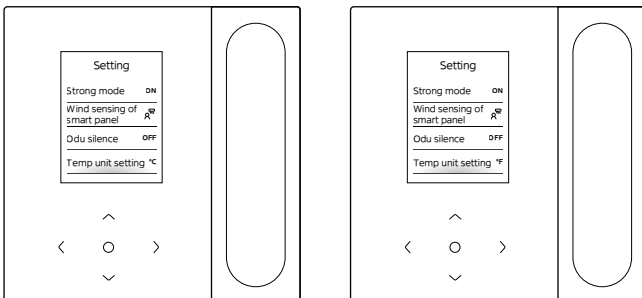

The temperature unit is Celsius by default. You can manually switch the unit between Celsius and Fahrenheit.

You can press "○" to enable or disable the temperature unit.

## 5.6 Room temp.display

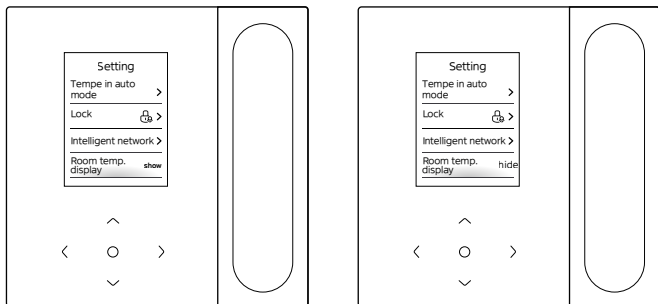

After the Room temp.display is enabled, if you return to the home page and does not operate the device, the device will automatically display the room temperature and presents a room temperature icon.

You can press "  " to enable or disable the function.

### CAUTION

- In auto mode, the room temperature is displayed forcedly.

## 5.7 IDU lighting

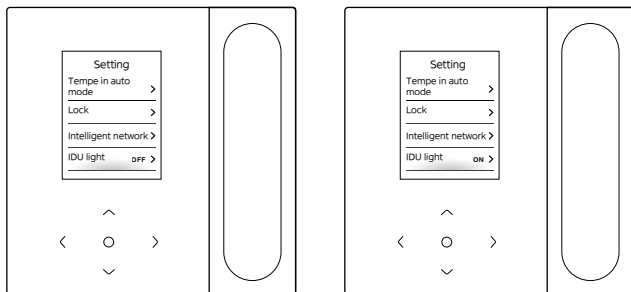

After the IDU lighting is enabled, the IDU display LED will light up. After the IDU lighting is disabled, the IDU display LED will turn off.

You can press " ○ " to turn on or off the IDU lighting.

## 5.8 Backlight time

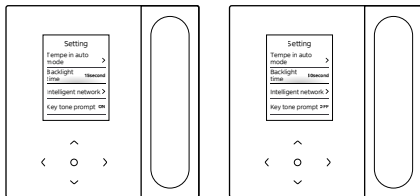

The backlight time can be set to 15s, 30s, or 60s. After the setting, if the device fails to receive any command within the set backlight time, it will enter the standby interface.

You can press "  " to adjust the backlight time.

## 5.9 Backlight brt

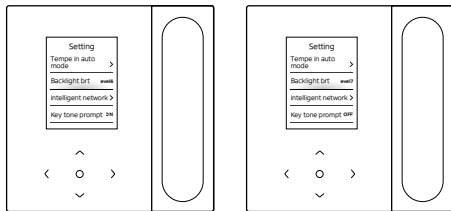

The Backlight brt has 10 levels, used to set the display brightness of the device. The brightness increases from level 1 to 10.

You can press "  " to adjust the backlight brightness.

## 5.10 The temperature setting in auto mode

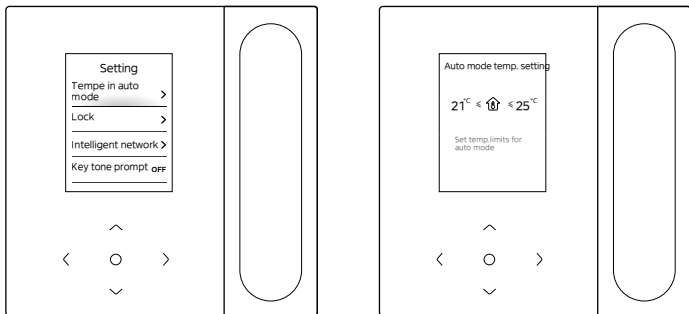

The temperature setting in auto mode enables you to set the temperature in auto cooling/heating mode, and maintain the indoor temperature within the set range.

Press " $\vee$ " or " $\wedge$ " to enter the temperature setting in auto mode, press " $<$ " or " $>$ " to select an item, and press " $\vee$ " and " $\wedge$ " to adjust the range.

## 5.11 Key lock

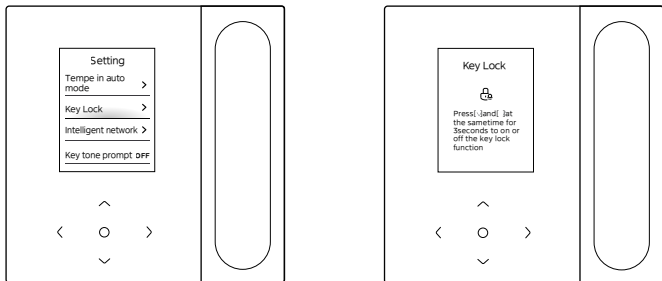

The key lock serves to prevent mis-operation of the children. After it is enabled, the buttons of the device will be locked and cannot be operated until the key lock is unlocked.

Press "∨" and "∧" at the same time to enable the key lock, and press "∨" and "∧" at the same time to disable the key lock.



## 5.12 Daylight saving time

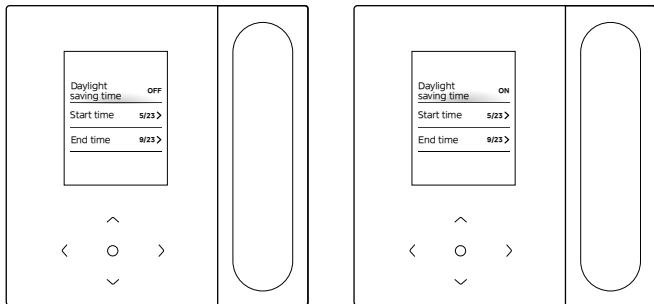

### Daylight saving time

You can enable or disable daylight saving time, and set the start time and end time.

Find daylight saving time in the function setting interface, and press "○" to enter the setting interface. Then, press "∨" or "∧" to set the date and time, and press "○" to switch. After the setting, press " back " to return for settings to take effect.

## 5.13 Date and time setting

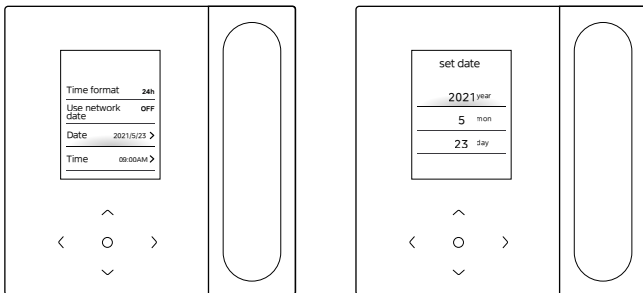

### Date and time

You can select the network time (Internet connection required) or manually set the time.

Find the date and time in the function setting interface, find the time display mode, and press "○" to enter the setting interface. Then, press "∨" and "∧" to set the date and time, and press "<" or ">" to switch. After the setting, press "○" or "back" to return for settings to take effect.

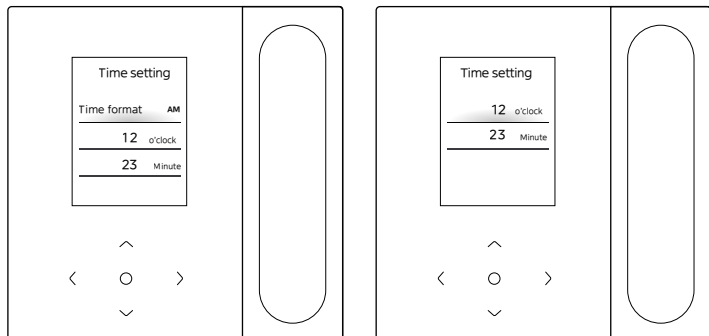

### Time display

Time can be displayed in 12-hour or 24-hour format.

Find the date and time in the function setting interface, find the time display mode, and press " ○ " to enter the setting interface.

## 5.14 One-to-more

One wired controller can control more than one IDU (up to 16 IDUs). One to more control includes group control and individual control. Under group control, the device sends commands to all IDUs in a unified manner. Under individual control, the device sends commands to any IDU in the system.

### (1) One to more group control

Enable the one to more function by entering the Engineering Settings > IDU Settings > SiteConfig. Once this function is enabled, the system enters the one to more group control by default. Under group control, the device sends commands to all IDUs and all IDUs execute the same commands. The main interface of the device under one to more group control is the same as that under one to one control. The function in the list should be subjected to the IDU.

### (2) One to more individual control

Under one to more group control, you can switch to individual control through the one to more individual control in the list. Under individual control, the main interface of the device switches to the main interface of individual control.

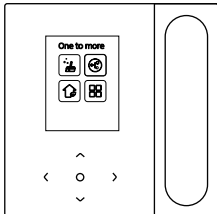

One-to-more individual control

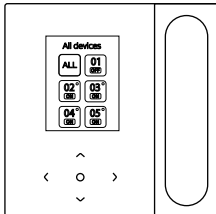

Main interface of individual control

On the main interface of one-to-many individual control, press "back" to quit from such control. Press "v" or "^" to switch the control object. The control object can be all IDUs or any IDU. Upon selection of the control object, press "o" to enable rapid power on/off. Press "o" to set the parameters.

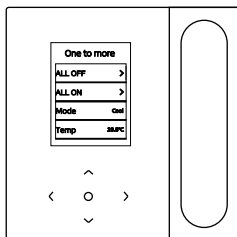

Fast startup

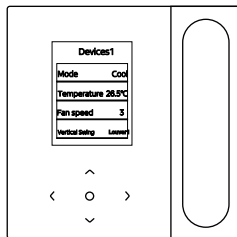

Parameter setting

 **CAUTION**

- Under individual control, you can enable swing setting in "Engineering Settings".

## 5.15 Fault Prompt

### Fault List

C51/E9 communication fault between wired controller and IDU

Press "Information" to view error codes on the homepage when fault occurs.

### Error display

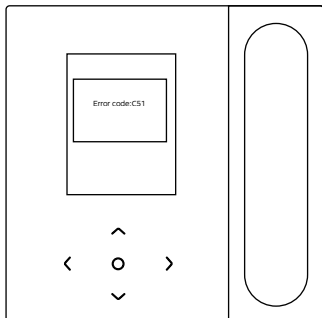

1. In case any IDU or ODU fails, the wired controller displays the fault code. In case a communication fault occurs between the wired controller and any of the IDUs, the wired controller reports "C51".
2. The wired controller can record up to 10 faults, each of which includes the address of the faulty device, the fault code, and the time when the fault occurs.

## 6 FAQ

- **The air conditioner is not working, but prompts that neither cooling nor heating option can be set. What should I do?**

The set mode is inconsistent with the operating mode of ODU. Please change the set mode to cooling/heating.

- **The word "Filter" is displayed on the operation panel. What should I do?**

Please contact the after-sales service to clean or replace the filter/heat exchanger. Please contact your local dealer.

- **What should I do if the air conditioner is not running as strongly as it should be? What are the possible causes?**

Please check in the following sequence:

1. Whether the set mode is cooling or heating;
  2. Whether the louvers of the air outlet face down;
  3. Whether there is any barrier 20 cm around the IDU and whether the IDU is clogged and needs to be cleaned.
  4. If the problem persists, Please contact your local dealer.
- **How can I adjust the temperature on my air conditioner? What is the ideal room temperature for human comfort?**

The set temperature on air conditioner should be different from the room temperature. The most comfortable temperature for summer is between 24°C and 26°C, and that for winter is between 18°C and 20°C. You may set the temperature depend on actual situations.

- **Why does the air outlet of my air conditioner drip?**

The room is filled with a great amount of moisture. Please close the doors and windows.

**Why does the ODU of my air conditioner drip?**

1. During cooling in summer, condensation water generated by the unit is discharged to the outside through the IDU drainage pipe. If the drainage pipe is close to the ODU, the condensation water may be mistaken for the water leaked from the ODU. The ODU does not drain any water during cooling.
2. During heating in winter, the ODU may be frosted. Then, the unit will defrost and the defrosted water will flow from the drainage outlet at the bottom of the ODU. This is a normal phenomenon instead of a fault of the air conditioner. To deal with this, you may contact the after-sales personnel or the installer to install an ODU drainage pipe.

- **How should I use a wired controller? Please provide simple operation instructions.**

Please scan the QR code on the user manual for the operation instructions.

- **Why does air conditioner fail to start after it is powered on?**

In winter, it takes some time for your air conditioner to warm up. Please wait a few minutes.



- **Why does air conditioner keep operating after it is powered off?**

After your air conditioner is powered off, there is some residual moisture inside the conditioner. It operates for a while to eliminate the moisture, so as to reduce the possibility of mould growth.

- **Why are the air conditioner functions non-adjustable?**

If the display panel presents a centralized controller icon, the air conditioner is locked. In this case, please contact the air conditioner system administrator.

## 7 INSTALLATION

### 7.1 Installation Precautions

- To ensure correct installation, read the "Installation" section of this manual.
- The content provided here covers warnings, which contain important information about safety that must be followed.

#### CAUTION

Entrust a local distributor or local service agent to appoint a qualified technician to perform the installation. Do not try to install the unit by yourself.

Do not knock, throw, or randomly disassemble the wired controller.

The wiring must be compatible with the wired controller current.

Use the specified cables, and do not place any heavy object on the wiring terminals.

The wired controller line is a low-voltage circuit, which cannot come into direct contact with the high voltage line or be laid in the same wiring tube together with the high voltage line. The minimum spacing of wiring tubes is 300 to 500 mm.

Do not install the wired controller in corrosive, flammable and explosive environments or places with oil mist (such as a kitchen).

Do not install the wired controller in a wet place and avoid direct sunlight.

Do not install the wired controller when it is powered on.

Please install the wired controller after painting the wall; otherwise, water, lime and sand may enter the wired controller.

## 7.2 Installation Method

### 7.2.1 Wiring requirements

One-to-more and two-to-more

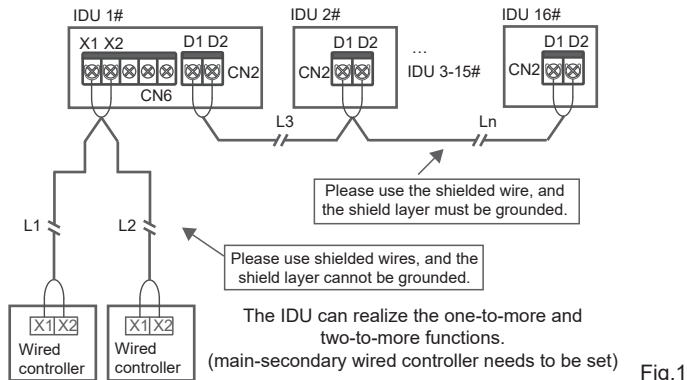

The one-to-more function must be set for the wired controller. After the communication between the wired controller and IDU lasts 3 minutes and 30 seconds, the control can be implemented.

### One-to-one

- Applicable to bi-directional communication between wired controller and IDU.
- One-to-one: One wired controller controls one IDU. The parameters displayed on the wired controller are updated in real time according to changes in the parameters of the IDU.
- The permissible longest wiring length of the system is 200 m.
- Communication cables between the IDU and the wired controller (X1, X2) may be connected in reverse order.

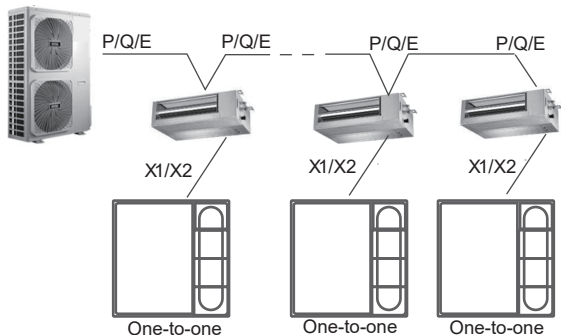

Fig.2

## Two-to-one

- Applicable to bi-directional communication between wired controller and IDU.
- Two-to-one: Two wired controller controls one IDU. The parameters displayed on the wired controller are updated in real time according to changes in the parameters of the IDU.
- Two-to-one: wired controller must be set as main or secondary. Refer to "Parameter settings C00" .
- The permissible longest wiring length of the system is 200 m.
- Communication cables between the IDU and the wired controller (X1, X2) may be connected in reverse order.

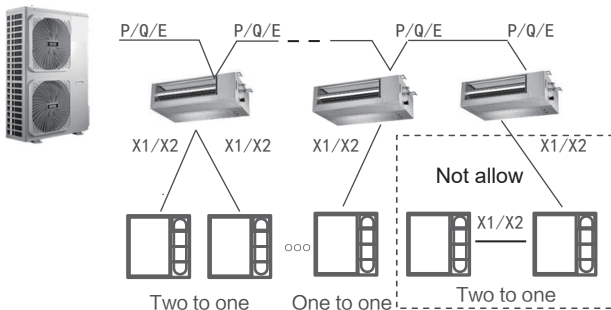
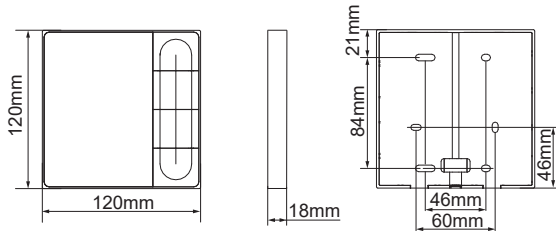

Fig.3

## 7.2.2 Installation Dimensions



Installation of bottom cap of the wired controller.

Screw hole installed on the wall, use four  $\phi 4 \times 20$ mm (Fig.4)

Or use two M4X25 screws to install the back cover on the 86 electrical box, and use two M4X20 screw to fix to the wall. (Fig.5)

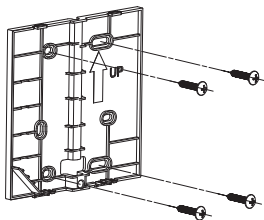
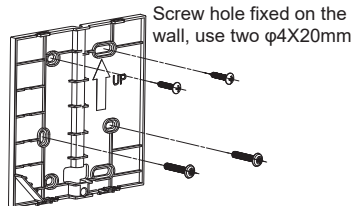

Fig.4



Screw hole installed on 86 electrical box, use two M4X25mm

Fig.5

Adjust the length of the two plastic screw bars in the accessories so there is a uniform distance between the electrical box screw bar and the wall. Make sure that it is as flat as the wall when installing the screw bar to the electrical box screw bar. (Fig.6)

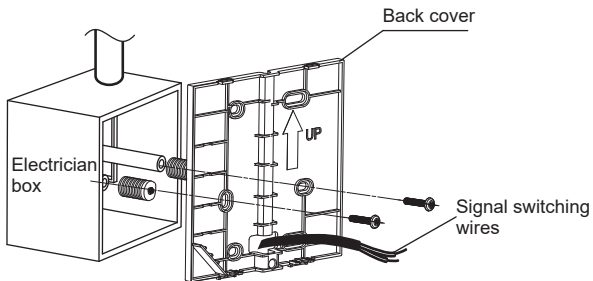
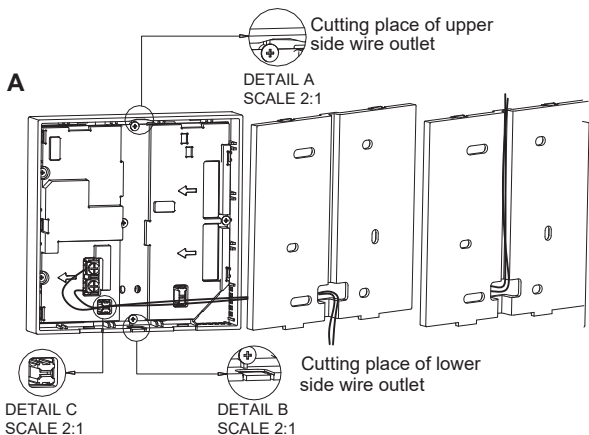

Fig.6

Use cross head screws to fix the wired controller bottom cover in the electric control box through the screw bar. Make sure that the wired controller bottom cover is on the same level after installation, and then install the wired controller back onto the bottom cover.

Fastening the screw too tightly will lead to deformation of the back cover.

### 7.2.3 Wire outlet



Wire clamp : For fixing wire trend

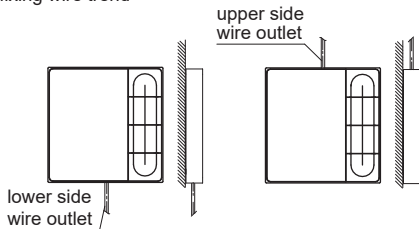

Fig.7



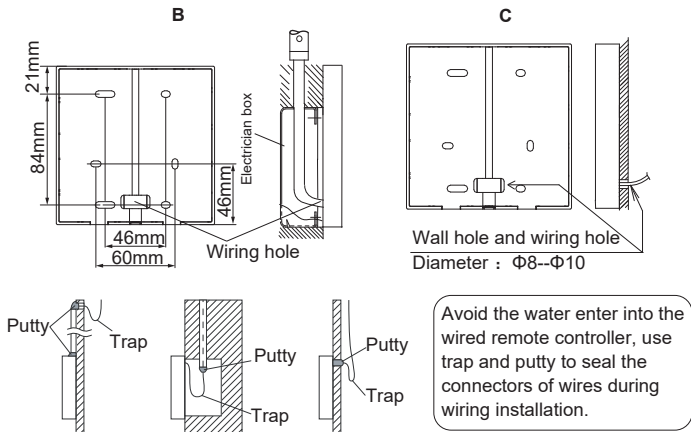

Fig.8

## 7.2.4 Wiring Installation

### NOTE

- The switch box and control wire for 2nd generation IDUs are not attached.
- Do not touch the wired controller main board.

### 7.2.5 Front cover installation

After adjusting the front cover, buckle the front cover; avoid clamping the communication switching wire during installation. (Fig. 9)

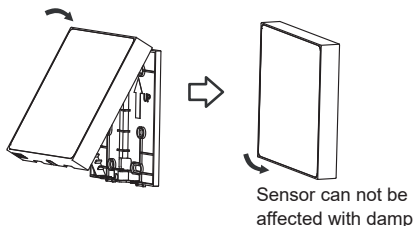

Fig.9

Correctly install the back cover and firmly buckle the front and back covers; otherwise, the front cover will fall off. (Fig.10)

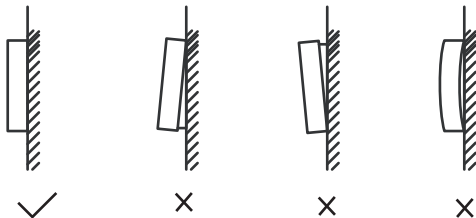
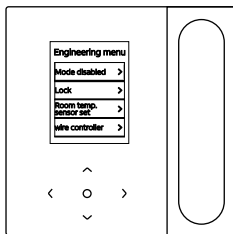

Fig.10

## 8 ENGINEERING SETTINGS

### 8.1 Parameter settings of the wired controller

- Parameters can be set in the power-on or power-off state.
- Hold "≡" and ">" for 3 seconds to enter the parameter setting interface.
- After entering the parameter setting interface, Press "∨" and "∧" to switch the parameter. Set parameters according to the Table of Parameter Settings. Press "○" to enter the parameter setting interface. Then press "<" and ">" to change parameter value and press "○" to save changes.
- Press the "back" button to return to the previous page until exiting the parameter setting or exiting the parameter setting after 60s without any operation.
- When it is in the parameter settings page, the wired controller does not respond to any remote control signal.



## 8.2 Engineering Menu

Menu	Submenu	Setting
Engineering Settings Interface	Mode disable	Auto, Cool, Heat, Fan, Dry
	Lock	Set temp.
		Speed
	Room temp. sensor set	Room temp. sensor position
		Room temp. sensor
	WDC config	For details, see the "Wired controller Configuration"
	IDU set item	For details, see the "IDU settings"
	Set IDU address	Set IDU address
	ODU set item	For details, see the "ODU settings"
	System running status query	Fault info
		ODU info
		IDU info
		WDC info
	IDU time info	Runtime
	ODU time	Runtime
		Fan 1 runtime
		Fan 2 runtime
	ODU time	Compressor 1 runtime
		Compressor 2 runtime
	Other	Restore Settings
Self-check		

### 8.3 Wired controller Configuration

Menu	Submenu	Third-level menu	Default	Remarks
Engineering Settings Interface	Set main and sec. wired controller	main/second	Master WDC	
	0.5 degree Temp. Adjustment or not	Set temp. format: 0.5/1	0.5	
	Set temp. range/cool and heat	Set upper and lower temp. limits in cooling/heating mode	Common SDV6 IDUs: 16°C–30°C Common SDV5 IDUs: 17°C–30°C SDV6 FAPU: 13°C–30°C SDV5 FAPU: 13°C–30°C	The room temperature range that can be set with a wired controller is 13–30°C. The FAPU treats the temperature below 16°C as 16°C, and the wired controller displays the actual set operating temperature of the FAPU.
	Rem control rcp of wired controller	Enable/Disable	Enable	
	Wired controller Auto restore	Enable/Disable	Enable	
	Perf. degradation	On/Off	Off	only SDV6 IDU
	Filter blocked rate	On/Off	Off	only SDV6 IDU
	Filter clean reminder	00: No reminder to filter 01:500h,02:1000h, 03:2500h,04:5000h	500h	
	Filter reset			
	wired controller light	On/Off	On	
Separ one-to-more ctrl/swing	On/Off	Off	only SDV6 IDU	
After hours	30 min, 60 min, 90 min, 120 min, 180 min, 240 min, invalid	Invalid		

## 8.4 IDU settings

### SDV5 protocol

IDU set item	Parameter name	Parameter range	Remarks
On-site settings	Static pressure setting of IDU	00/01~19/FF	The IDU sets the static pressure based on the set gear, FF (VRF unit: main board DIP of IDU; other models: reserved)
	On-site air flow adjustment factor	00/01	00: 1, 01: 1.1
IDU setting	IDU buzzer	00/01	00: Not sound; 01: Sound
	EXV opening selection during heating standby	00/01/02/FF	00: 56P, 01: I72P, 02: 00P; FF: IDU DIP
	Mode changeover interval in Auto mode (min)	00/01/02/03	00: 15min, 01: 30min, 02: 60min, 03: 90min
	Power failure memory for IDU	00/01	00: Not available; 01: Available
	Up/down swing for IDU	00/01	00: Not available; 01: Available Note: Not supported on FAPUs.
	Left/right swing for IDU	00/01	00: Not available; 01: Available Note: Not supported on FAPUs.
	Remote control instruction receiving on IDU display panel	00/01	00: Receive; 01: Not receive
Auxiliary heat source available for IDU	00/01	00: Not available; 01: Available Note: Not supported on FAPUs.	

IDU set item	Parameter name	Parameter range	Remarks
IDU setting	Set outdoor temperature for auxiliary heat source / alternative heat source to turn on	Celsius: -5 to 20 Fahrenheit: 23 to 68	1°C or 1°C accuracy Note: Not supported on FAPUs.
	Set outdoor temp. when the third-party heater works separately	00/01/02/03/ 04/05/06/07/ 08/09/10/11/ 12/13/14/15/ 16/17	00: No limit; 01: -16°C/4°F; 02: -14°C/7°F; 03: -12°C/10°F; 04: -9°C/15°F; 05: -7°C/20°F; 06: -4°C/25°F; 07: -1°C/30°F; 08: 2°C/35°F; 09: 4°C/40°F; 10: 7°C/45°F; 11: 10°C/50°F; 12: 13°C/55°F; 13: 16°C/60°F; 14: 18°C/65°F; 15: 21°C/70°F; 16: 24°C/75°F; 17: 27°C/80°F
Fan speed setting	Upper limit of automatic fan speed in cooling mode	04/05/06/07	04: Speed 4; 05: Speed 5; 06: Speed 6; 07: Speed 7 Note: Not supported on FAPUs.
	Upper limit of automatic fan speed in heating mode	04/05/06/07	04: Speed 4; 05: Speed 5; 06: Speed 6; 07: Speed 7 Note: Not supported on FAPUs.
	Air flow setting at fan speed 7	00/01	00: Constant speed; 01: Constant air flow Note: Not supported on FAPUs.
	Fan speed setting in heating standby mode	00/01/14	00: Thermal; 01: Speed 1; 14: Fan speed before going to standby mode Note: Not supported on FAPUs.
	Time to stop the fan of IDU in heating mode (Thermal)	00/01/02/03/04/ FF	00: Fan on; 01: 4 min; 02: 8min; 03: 12min; 04: 16min; FF: Main board DIP Note: Not supported on FAPUs.

IDU set item	Parameter name	Parameter range	Remarks
Temp. setting	IDU's anti-cold wind temperature setting in heating mode	00/01/02/03/FF	Common IDUs (models 1, 3, 4, 6, and 8): 00: 15; 01: 20; 02: 24; 03: 26; FF: Invalid  FAPU (models 2 and 7): 00: 14; 01: 12; 02: 16; 03: 18; FF: Reserved Note: Not supported on FAPUs.
	Anti-cold wind temperature setting of special IDUs	00/01/02/03/F	00/01/02/03: corresponds to different values; 04: anti-cold wind invalid This setting item is displayed in the anti-cold wind setting of special IDUs such as FAPUs and AHU-KITs
	Cooling return difference temp.	00/01/02/03/04	00: 1°C; 01: 2°C; 02: 0.5°C; 03: 1.5°C; 04: 2.5°C Note: Not supported on FAPUs.
	IDU heating temp. compensation	00/01/02/03/04/FF	VRF unit: 00: 6°C; 01: 2°C; 02: 4°C; 03: 6°C; 04: 0°C; FF: main board DIP of master IDU Split uni: 00: 6°C; 01: 2°C; 02: 4°C; 03: 8°C; 04: 0°C; FF: reserved Mini VRF unit: 00: 6°C; 01: 2°C; 02: 4°C; 03: 8°C; 04: 0°C; FF: Reserved Note: Not supported on FAPUs.



IDU set item	Parameter name	Parameter range	Remarks
Temp. setting	IDU cooling temp. compensation	VRF unit: 00/01/FF Split unit: 00/01/02/03/FF Mini VRF unit: 00/01/02/03/04/ FF	VRF unit: 00: 0°C; 01: 2°C; FF: main board DIP of IDU Split uni: 00: 0°C; 01: 1°C; 02: 2°C; 03: 3°C; FF: Reserved Mini VRF unit: 00: 0°C; 01: 1°C; 02: 2°C; 03: 3°C; 04: -1°C; FF: Reserved Note: Not supported on FAPUs.
Other settings	Sterilization setting	00/01	00: Sterilization unavailable; 01: Plasma sterilization
	Drying time at self-cleaning	00/01/02/03	00: 10 min; 01: 20 min; 02: 30 min; 03: 40 min Note: Not supported on FAPUs.
Energy conservation option	Initial static pressure detection	00/01	00: Not reset initial static pressure; 01: Reset initial static pressure Note: Not supported on FAPUs.
FAPU setting	Fresh air dry contact 1 - fan	00/01	00: Disconnect; 01: Enable Note: Not supported on FAPUs.
	Fresh air dry contact 2 - economizer	00/01	00: Disconnect; 01: Enable Note: Not supported on FAPUs.
	Fresh air dry contact 3 - humidifier	00/01	00: Disconnect; 01: Enable Note: Not supported on FAPUs.

## SDV6 protocol

IDU set item	Parameter name	Parameter range	Remarks
On-site set item	Static pressure setting of IDU	00/01~19/FF	The IDU sets the static pressure based on the set gear, FF (VRF unit: main board DIP of IDU; other models: reserved)
	High ceiling setting	00/01/02	00: 3 m; 01: 4 m; 02: 4.5 m Note: Not supported on FAPUs.
	On-site air flow adjustment factor	00/01/02/03/04/05/06	00:1; 01:1.05; 02: 1.1; 03:1.15; 04:0.95; 05:0.9; 06:0.85
	Q4/Q4 min air outlet closed 1	00/01	00: Free control; 01: Close
	Q4/Q4 min air outlet closed 2	00/01	00: Free control; 01: Close
	Q4/Q4 min air outlet closed 3	00/01	00: Free control; 01: Close
	Q4/Q4 min air outlet closed 4	00/01	00: Free control; 01: Close
	Cooling/heating only for IDU	00/01	00: Cooling and heating; 01: Cooling only
	One-to-many of WDC enabled	00/01	00: No; 01: Yes
IDU setting	IDU buzzer	00/01/02	00: Not sound; 01: Sound; 02: Display panel only
	EXV opening selection during heating standby	00/01/02/14	00: 56P; 01: 72P; 02: 00P; 14: Auto regulation

IDU set item	Parameter name	Parameter range	Remarks
IDU setting	Mode changeover interval in Auto mode (min)	00/01/02/03	00: 15min; 01: 30min; 02: 60min; 03: 90min
	Power failure memory for IDU	00/01	00: Not available; 01: Available
	Remote control instruction receiving on IDU display panel	00/01	00: Receive; 01: Not receive
	Set outdoor temperature for auxiliary heat source / alternative heat source to turn on	Celsius degree: -25 to 0 Fahrenheit: -13 to 68	1°C or 1°F accuracy

IDU set item	Parameter name	Parameter range	Remarks
IDU setting	Set outdoor temp. when the third-party heater works separately	00/01/02/03/04/ 05/06/07/08/09/ 10/11/12/13/14/ 15/16/17	00: No limit; 01: -16°C/4°F; 02: -14°C/7°F; 03: -12°C/10°F; 04: -9°C/15°F; 05: -7°C/20°F; 06: -4°C/25°F; 07: -1°C/30°F; 08: 2°C/35°F; 09: 4°C/40°F; 10: 7°C/45°F; 11: 10°C/50°F; 12: 13°C/55°F; 13: 16°C/60°F; 14: 18°C/65°F; 15: 21°C/70°F; 16: 24°C/75°F; 17: 27°C/80°F
	Indoor temperature for auxiliary heat source / alternative heat source to turn on	Celsius: 10 to 30 Fahrenheit: 50 to 86	1°C or 1°F

IDU set item	Parameter name	Parameter range	Remarks
IDU setting	Indoor temperature for auxiliary heat source/alternative heat source to turn on	0-7	0 to 7 represent 0 to 7°C/°F
	Indoor temperature for auxiliary heat source/alternative heat source to turn off	0-10	0 to 10 represent -4 to 6°C/°F
	IDU control type	00/01/02	SDV6 FAPUs,SDV6AHU-KIT:Valid; SDV6 FAPUs,SDV6AHU-KIT:Valid; 00: Supply air temperature control; 01: Room temperature control; 02: Return air temperature control
	Auto dry function	00/01	00: Invalid; 01: Valid; Note: Not supported on FAPUs.
Fan speed setting	Air flow setting at fan speed 7	00/01	00: Constant speed; 01: Constant air flow
	Fan speed setting in cooling standby mode	00/01/02/03/04/ 05/06/07/14	00: Delayed fan shutdown; 01: Speed 1; 02: Speed 2; 03: Speed 3; 04: Speed 4; 05: Speed 5; 06: Speed 6; 07: Speed 7; 14: Fan speed before going to standby mode
	Standby fan speed L1 range in dry mode	00/01/02/03	00: Fan off; 01: L1; 02: L2; 03: Speed 1; Note: Not supported on FAPUs.
	Fan speed setting in heating standby mode	00/01/14	00: Thermal; 01: Speed 1; 14: Lock speed 1
	Time to stop the fan of IDU in heating mode (Thermal)	00/01/02/03/04	00:Fan off; 01: 4min; 02: 8min; 03: 12min; 04: 16 min (SDV6 protocol); Note: Not supported on FAPUs.

IDU set item	Parameter name	Parameter range	Remarks
Temp. setting	IDU's anti-cold wind temperature setting in heating mode	00/01/02/03/04	Common IDUs (models 1, 3, 4, 6, and 8): 0: 15; 1: 20; 2: 24; 3: 26; 04: Invalid
	Anti-cold wind temperature setting of special IDUs	00/01/02/03/04	00/01/02/03: corresponds to different values; 04: anti-cold wind invalid This setting item is displayed in the anti-cold wind setting of special IDUs such as FAPUs and AHU-KITs
	Cooling return difference temp.	00/01/02/03/04	00: 1°C; 01: 2°C; 02: 0.5°C; 03: 1.5°C; 04: 2.5°C
	Heating return difference temperature	00/01/02/03/04	00: 1°C; 01: 2°C; 02: 0.5°C; 03: 1.5°C; 04: 2.5°C
	IDU heating temp. compensation	00/01/02/03/04	00: 6°C; 01: 2°C; 02: 4°C; 03: 8°C; 04: 0°C; Note: Not supported on FAPUs.
	IDU cooling temp. compensation	00/01/02/03/04	00: 0°C; 01: 1°C; 02: 2°C; 03: 3°C; 04: -1°C; Note: Not supported on FAPUs.
	Max. indoor temp. drop D3 in dry mode	00/01/02/03/04	00: 3°C; 01: 4°C; 02: 5°C; 03: 6°C; 04: 7°C; Note: Not supported on FAPUs.
	Lower limit settings of cooling operating range	00/01/02/03/04/ 05/06/07	SDV6 FAPUs, SDV6 AHU-KITs: Valid
	Lower limit settings of heating operating range	00/01/02/03/04/ 05/06/07	SDV6 FAPUs, SDV6 AHU-KITs: Valid

IDU set item	Parameter name	Parameter range	Remarks
Remote and alarm settings	On/Off port logic via remote control	00/01	00: Remote off (closed); 01: Remote off (open) Note: When powered off remotely, the digital display of wired controller of SDV6 displays d6, while that of SDV5 does not display this code
	Remote ON/OFF control (implemented at the second stage)	00/01	00: Forced OFF control; 01: ON/OFF control
	Power off delay via remote control	00/01/02/03/ 04/05/06	00: No delay; 01: 1 min; 02: 2 min; 03: 3min; 04: 4min; 05: 5min; 06: 10min
	Alarm port logic	00/01	00: Alarm when closed; 01: Alarm when open
	Sterilization setting	00/01	00: Sterilization unavailable; 01: Sterilization available
	Drying time at self-cleaning	00/01/02/03	00: 10 min; 01: 20 min; 02: 30 min; 03: 40 min; Note: Not supported on FAPUs.
	Mildew-proof fan runtime (power off in cooling/dry mode, except power off due to faults)	00/01/02/03	00: Default; 01: 60s; 02: 90s; 03: 120s; Note: Not supported on FAPUs.
	Dirt proof for ceiling	00/01	00: Invalid; 01: Valid Note: Not supported on FAPUs.
	Condensation proof	00/01	00: Invalid; 01: Valid Note: Not supported on FAPUs.
	Refrigerant leak alarm reset	00/01	00: Not reset; 01: Reset

IDU set item	Parameter name	Parameter range	Remarks
Energy conservation option	Eta level in cooling mode	00/01/02	00: Level 1; 01: Level 2; 02: Level 3
	Eta level in heating mode	00/01/02	00: Level 1; 01: Level 2; 02: Level 3
	Initial static pressure detection	00/01	00: Not reset initial static pressure; 01: Reset initial static pressure
	Filter ending - initial static pressure setting	00/01.../19	00: 10Pa; 01: 20Pa; 02: 30Pa ~19: 200Pa
FAPU setting	Ambient temp. when preheater is on	00/01/02	00: 5°C; 01: 0°C; 02: (-5)°C



## 8.5 ODU settings

Parameter name	Parameter range
Energy rating of ODU	40% to 100%, every 1%
VIP IDU address	0-63
Heating and air supply enabled	00: Disable; 01: Enable
Silence level of ODU	Level 0 to14





## NOTE CONCERNING PROTECTION OF ENVIRONMENT



This product must not be disposed of via normal household waste after its service life, but must be taken to a collection station for the recycling of electrical and electronic devices. The symbol on the product, the operating instructions or the packaging indicate such disposal procedures. The materials are recyclable in accordance with their respective symbols. By means of re-use, material recycling or any other form of recycling old appliances you are making an important contribution to the protection of our environment. Please ask your local council where your nearest disposal station is located.

## PRODUCER

SINCLAIR CORPORATION  
Ltd. 16 Great Queen Street  
WC2B 5AH London United  
Kingdom  
[www.sinclair-world.com](http://www.sinclair-world.com)

This product was manufactured in China (Made in China).

## TECHNICAL SUPPORT

SINCLAIR Global Group s.r.o.  
Purkynova 45  
612 00 Brno  
Czech Republic  
Tel.: +420 800 100 285 | Fax: +420 541 590 124  
[www.sinclair-solutions.com](http://www.sinclair-solutions.com) | [info@sinclair-solutions.com](mailto:info@sinclair-solutions.com)

## REPRESENTATIVE

SINCLAIR Global Group  
s.r.o. Purkynova 45  
612 00 Brno Czech  
Republic

